

FIRST TEAM SPORTS INC.
HUTCHINSON, KS 67501
1-800-649-3688
www.firstteaminc.com

FAN3-2FP-TNR-15
TIP-IN-ROLL BLEACHER
PRODUCT SUBMITTAL

BLACK POWDER COATED STEEL FRAME

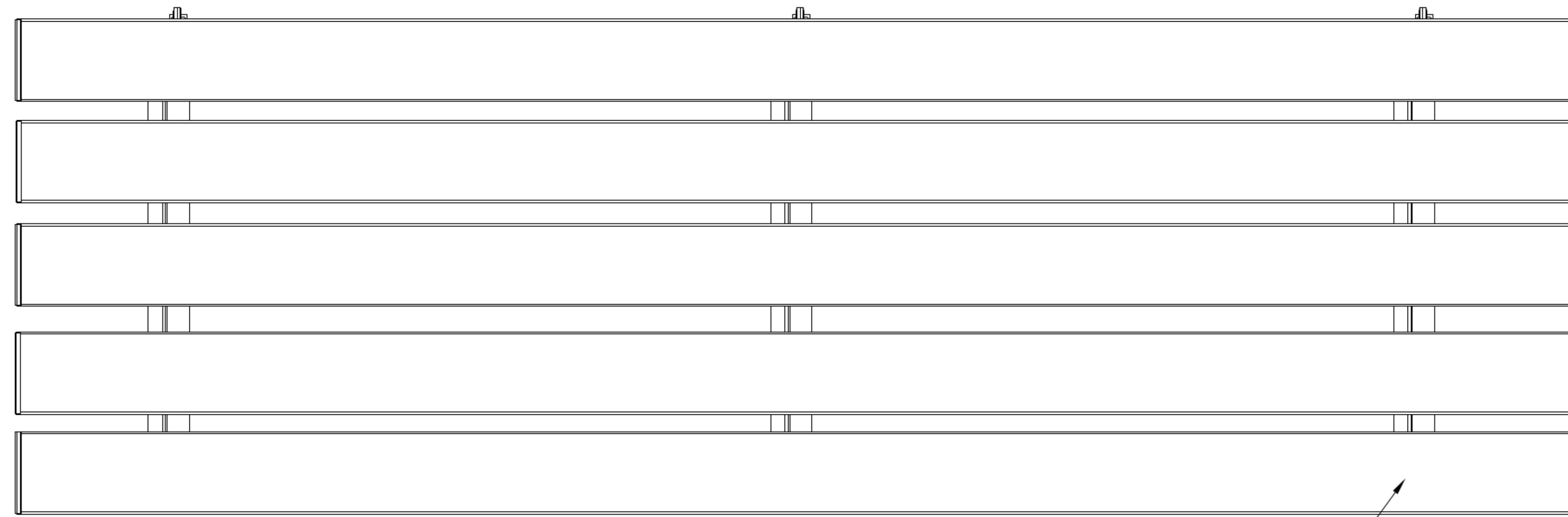

ALUMINUM END CAPS

9.5" WIDE CLEAR ANODIZED ALUMINUM PLANKS

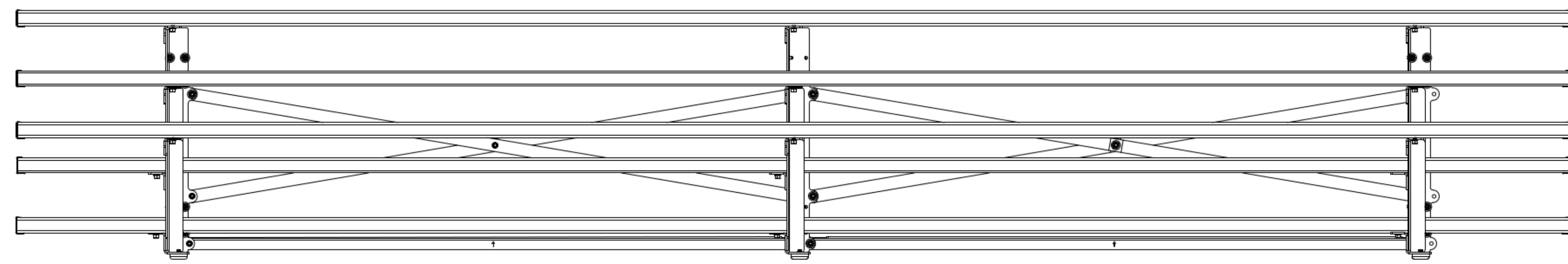

NON MARKING RUBBER FOOTPADS

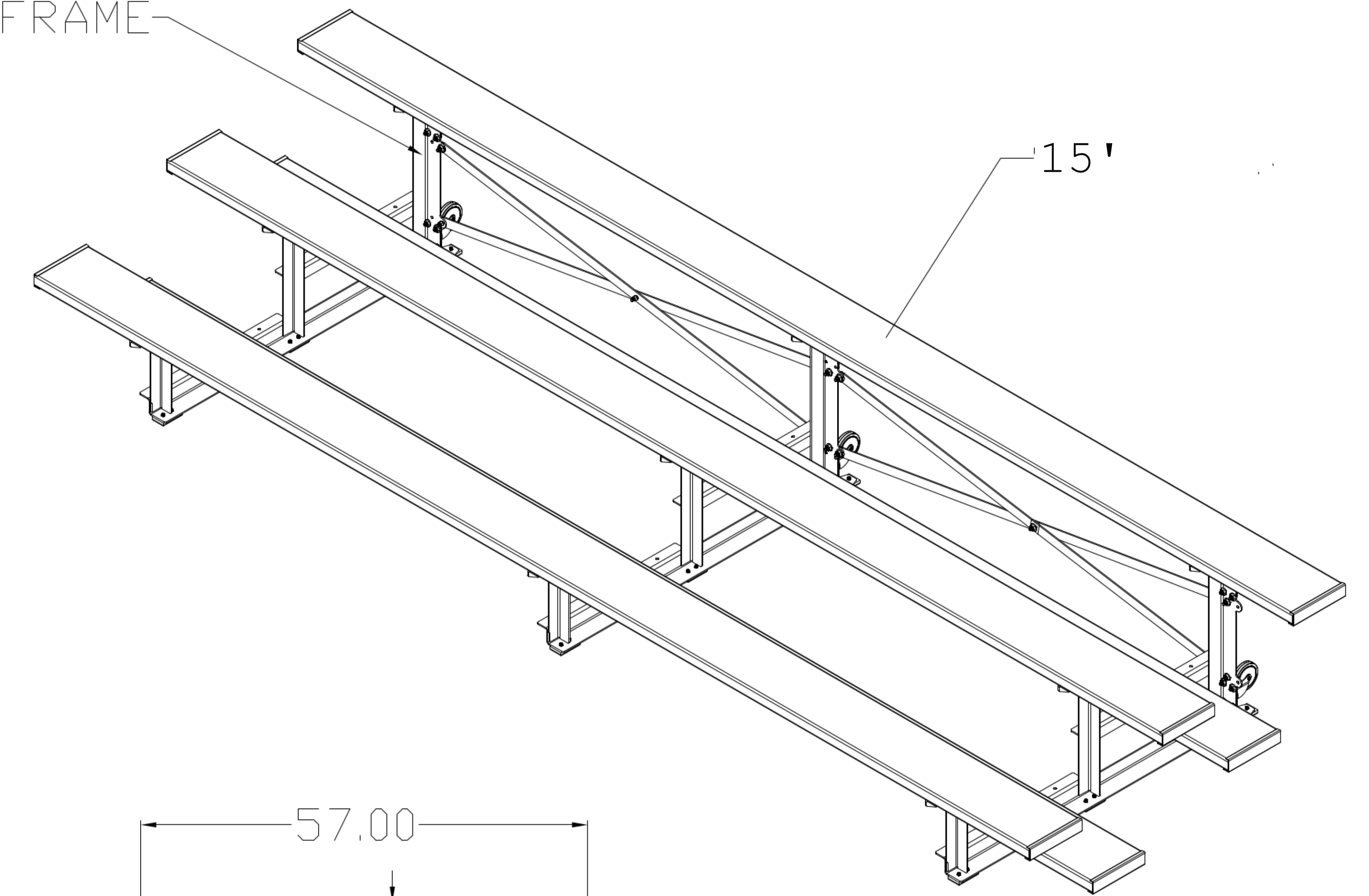

15'

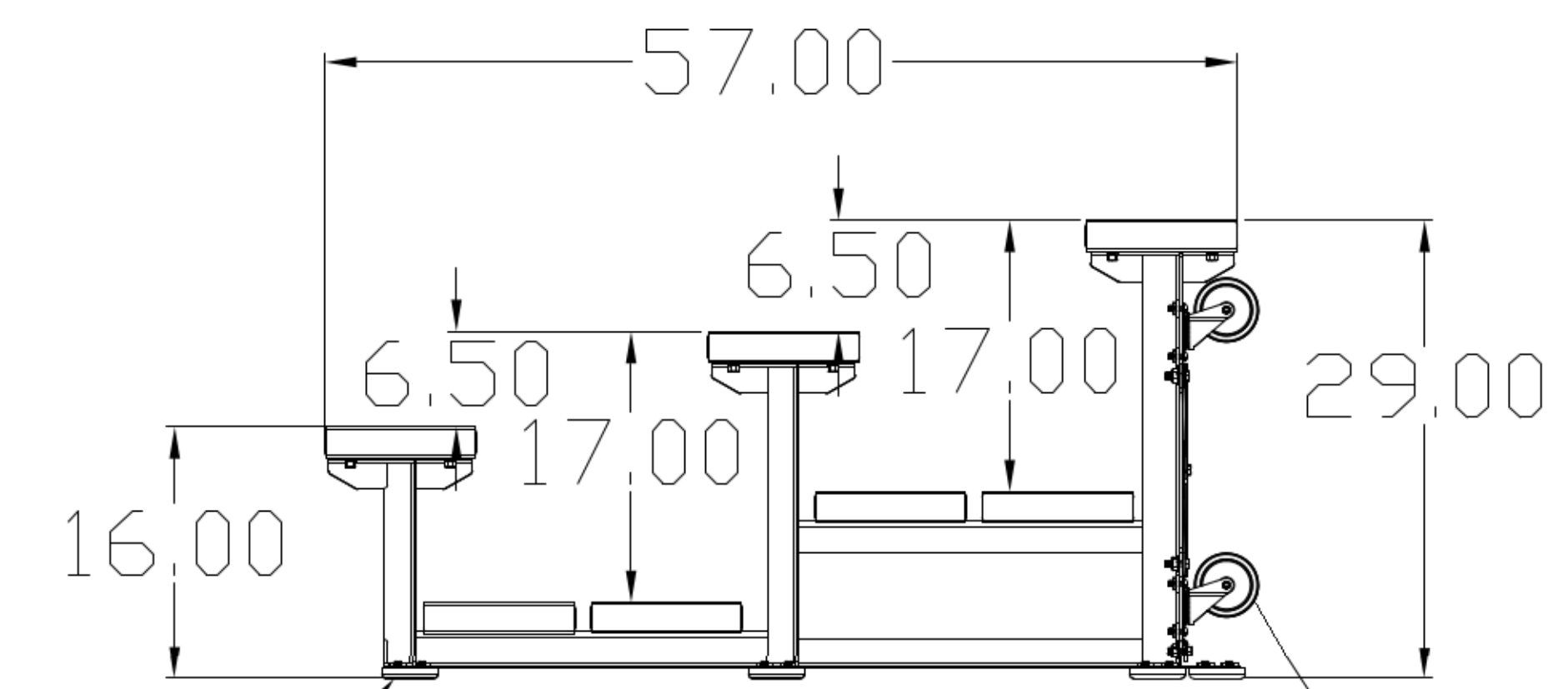

4" WHEELS

DOUBLE FOOTPLANK OPTION

CUSTOM COLORED PLANKS AVAILABLE UPON
REQUEST FOR AN ADDITIONAL CHARGE