

FIRST TEAM SPORTS INC.
HUTCHINSON, KS 67501
1-800-649-3688
www.firstteaminc.com

FAN4-1FP-21
PRODUCT SUBMITTAL

BLACK POWDER COATED STEEL FRAME

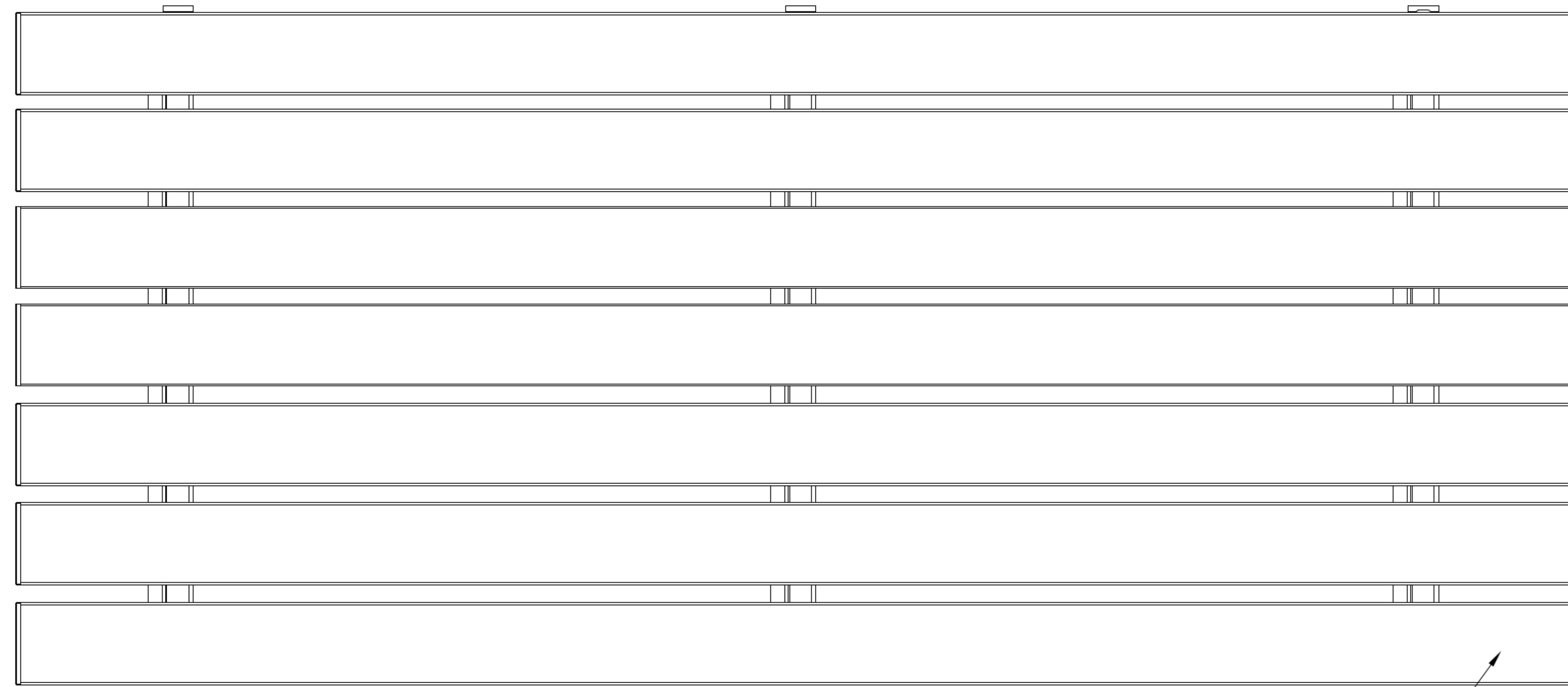

9.5" WIDE CLEAR ANODIZED ALUMINUM PLANKS

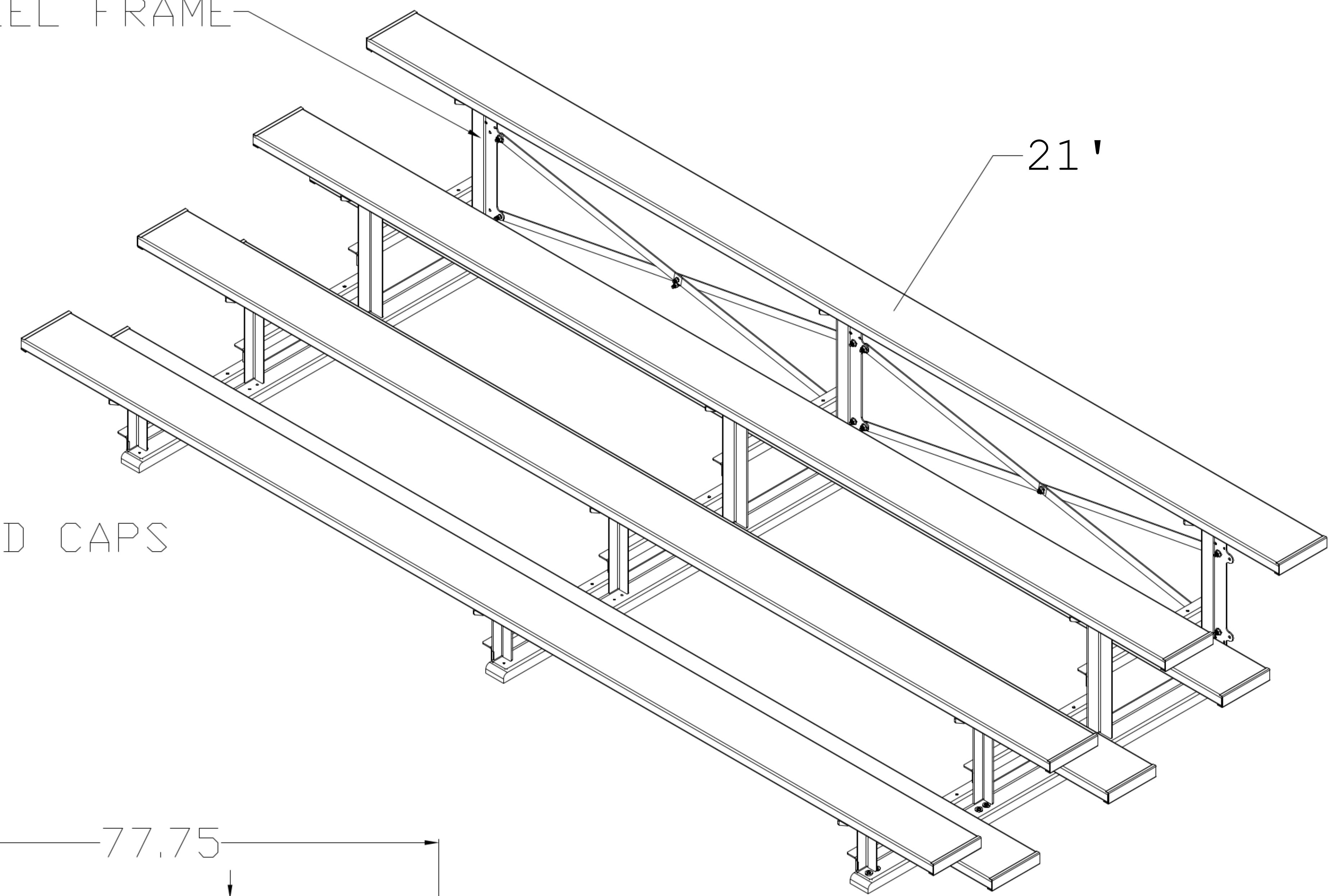
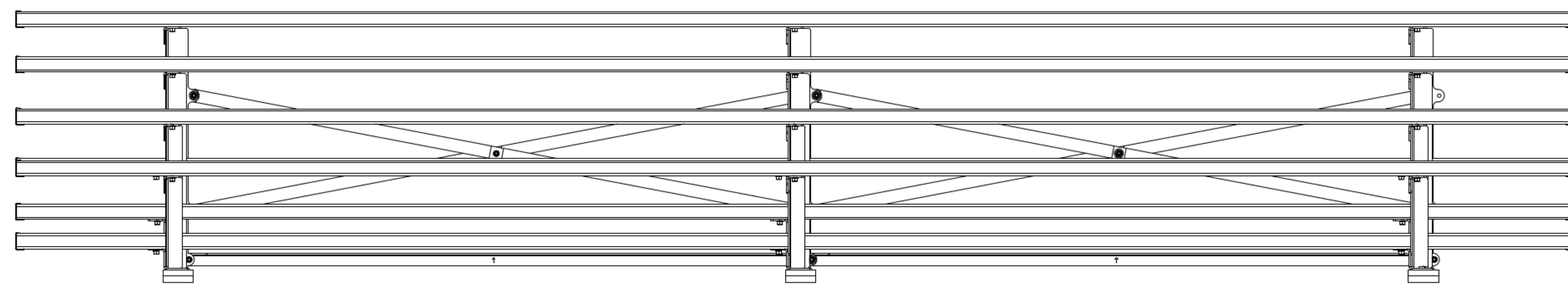

21'

ALUMINUM END CAPS

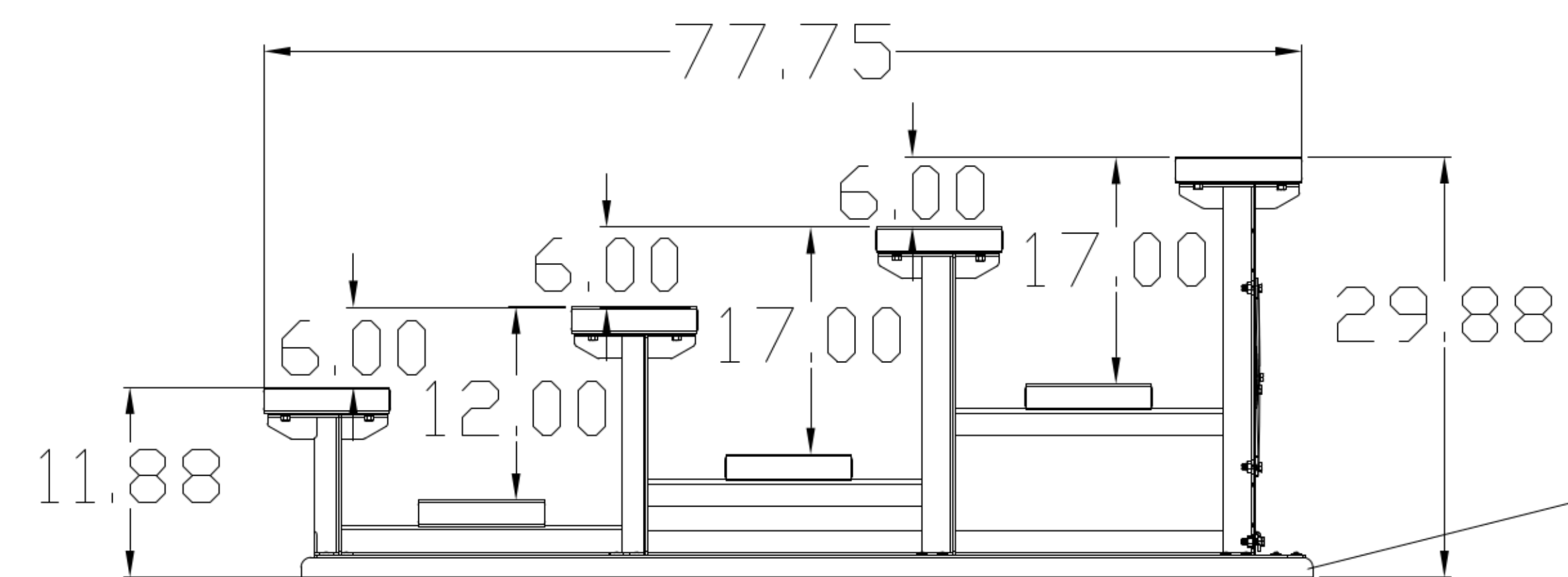

SINGLE FOOTPLANK OPTION

TREATED 2X4 WOOD RUNNERS

CUSTOM COLORED PLANKS AVAILABLE UPON
REQUEST FOR AN ADDITIONAL CHARGE