

FIRST TEAM SPORTS INC.
HUTCHINSON, KS 67501
1-800-649-3688
www.firstteaminc.com

FAN4-2FP-21
PRODUCT SUBMITTAL

BLACK POWDER COATED STEEL FRAME

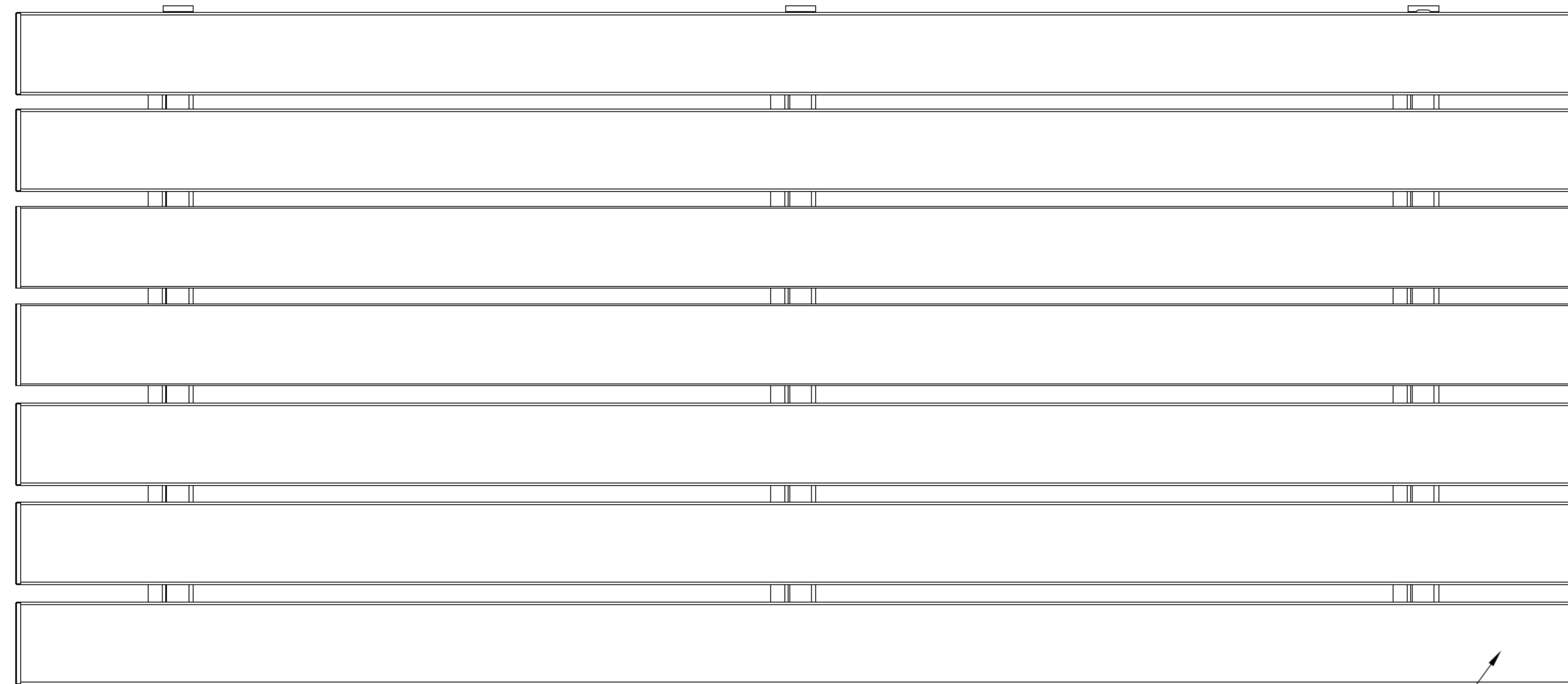

9.5" WIDE CLEAR ANODIZED ALUMINUM PLANKS

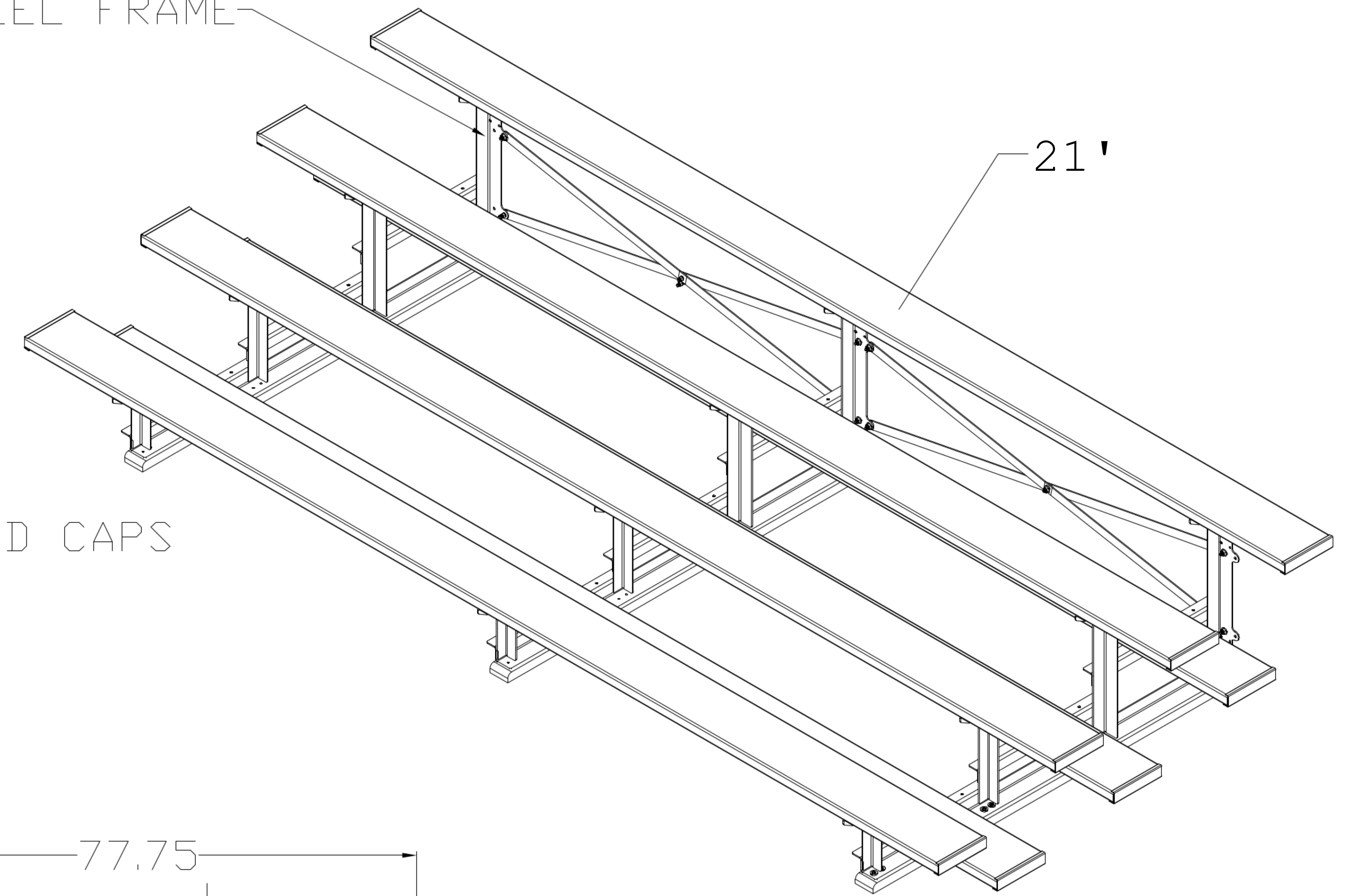
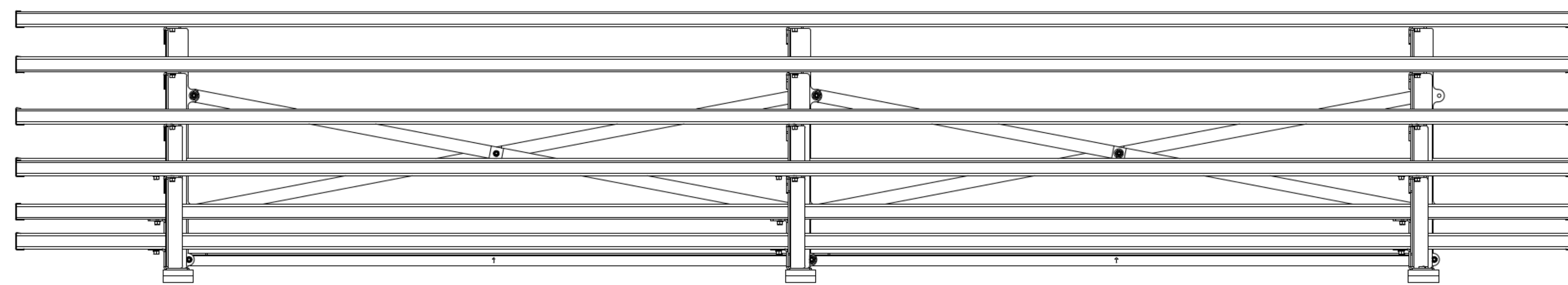

21'

ALUMINUM END CAPS

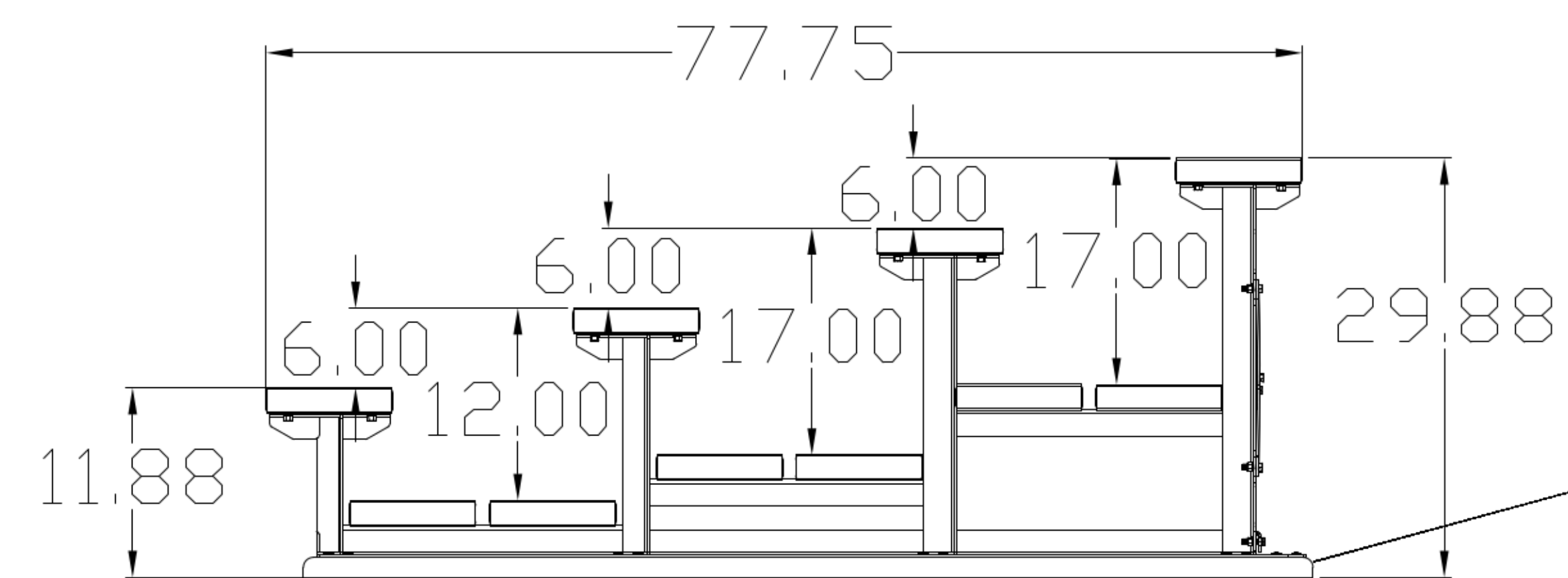

DOUBLE FOOTPLANK OPTION

TREATED
2X4 WOOD
RUNNERS

CUSTOM COLORED PLANKS AVAILABLE UPON
REQUEST FOR AN ADDITIONAL CHARGE