

FIRST TEAM SPORTS INC.
HUTCHINSON, KS 67501
1-800-649-3688
www.firstteaminc.com

FAN3-1FP-15
PRODUCT SUBMITTAL

BLACK POWDER COATED STEEL FRAME

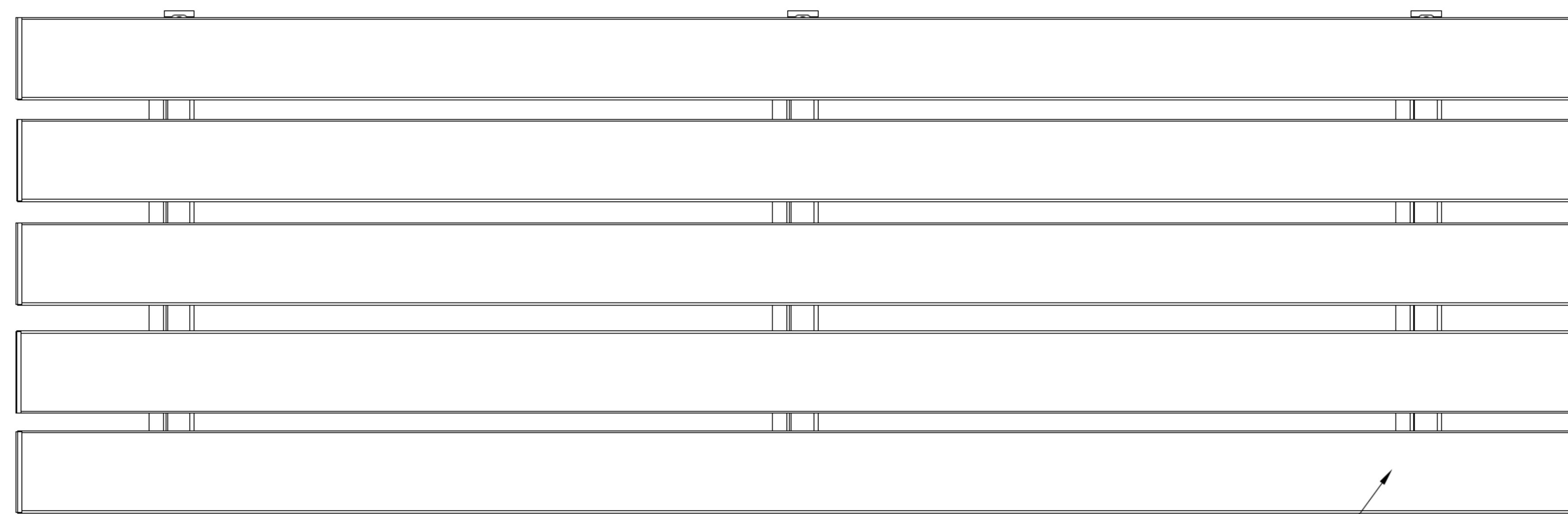

ALUMINUM END CAPS

9.5" WIDE CLEAR ANODIZED ALUMINUM PLANKS

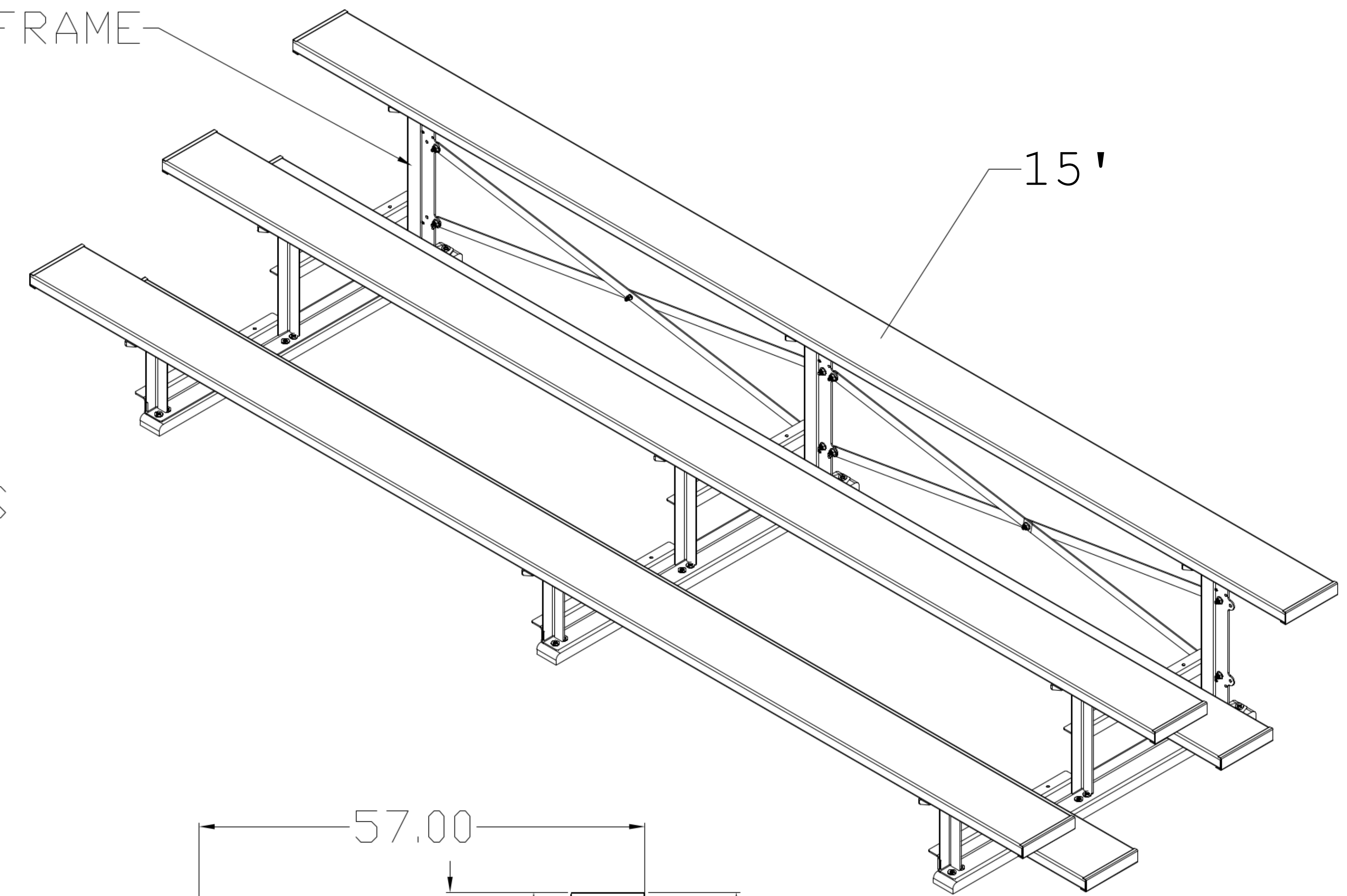
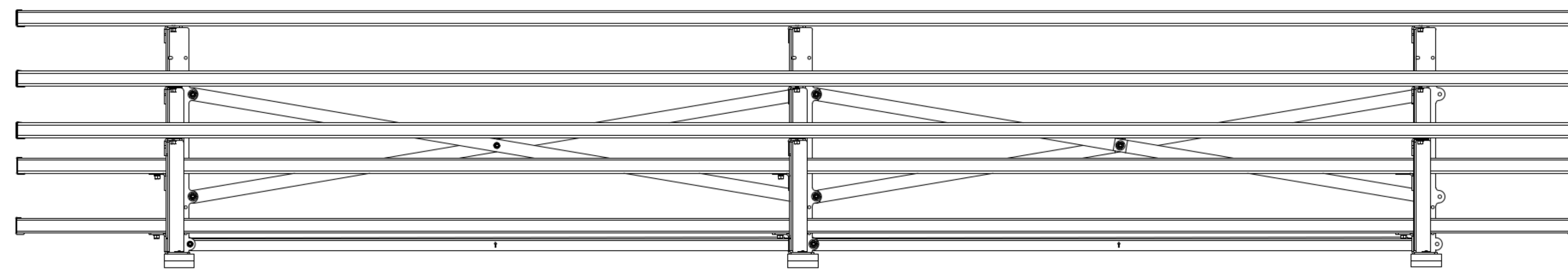

15'

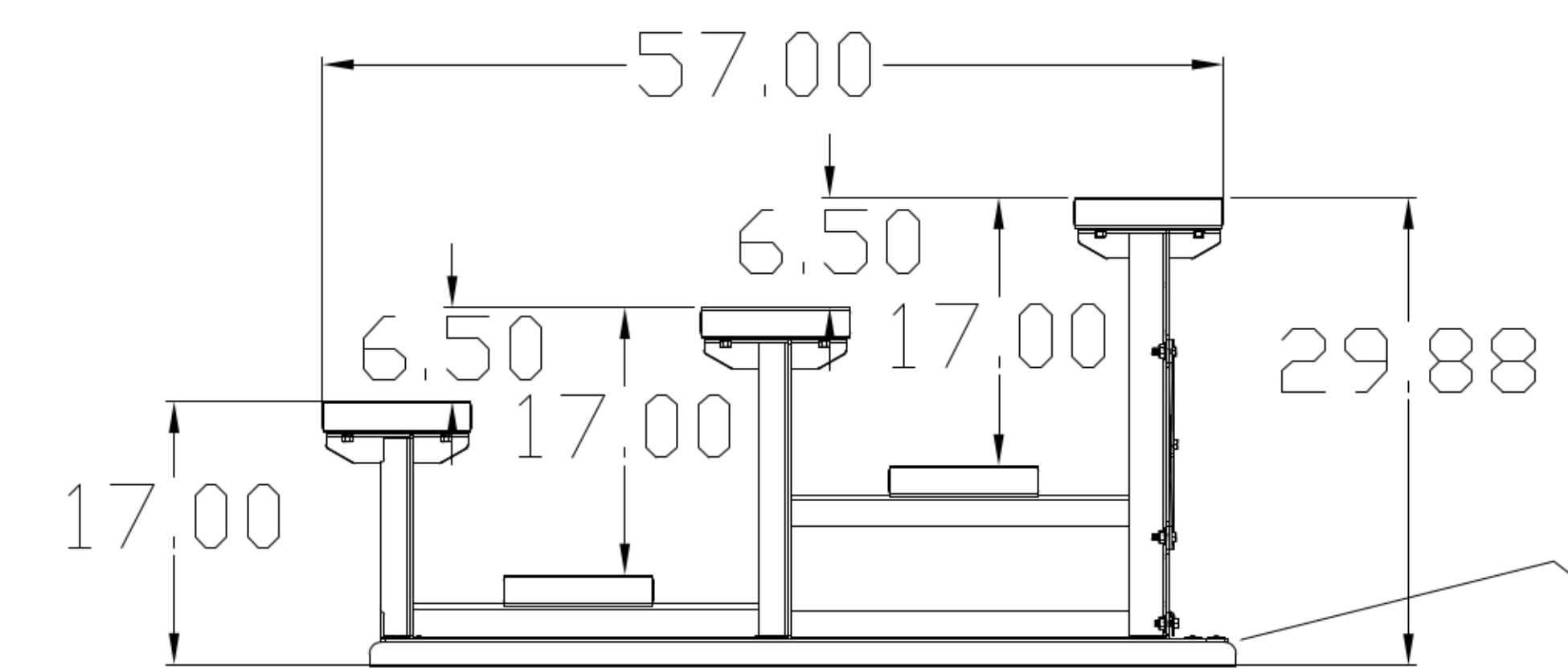

TREATED
2X4 WOOD
RUNNERS

SINGLE FOOTPLANK OPTION

CUSTOM COLORED PLANKS AVAILABLE UPON
REQUEST FOR AN ADDITIONAL CHARGE